

PRIME DESIGN™

A Safe Fleet Brand

AAL-8011

2015+ Ford Transit-H3 Rear Door Access Ladder

Dimensional Specifications on Page 2

Configuration as shown:

Finish: Bright Anodized
Vehicle-Specific Mounting Bracket System
Overall Weight (empty): 19.50 lbs

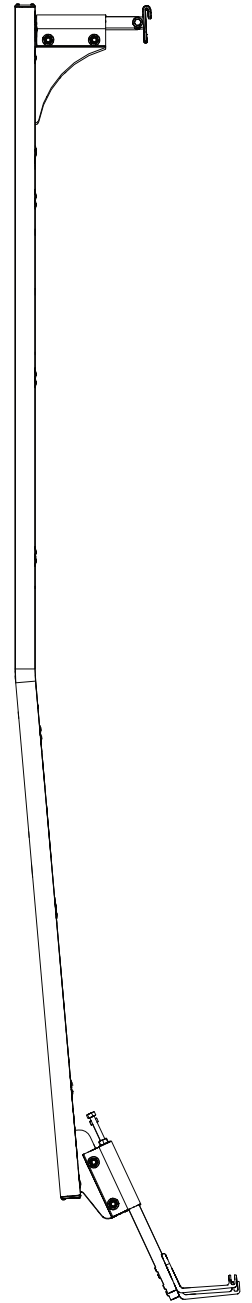
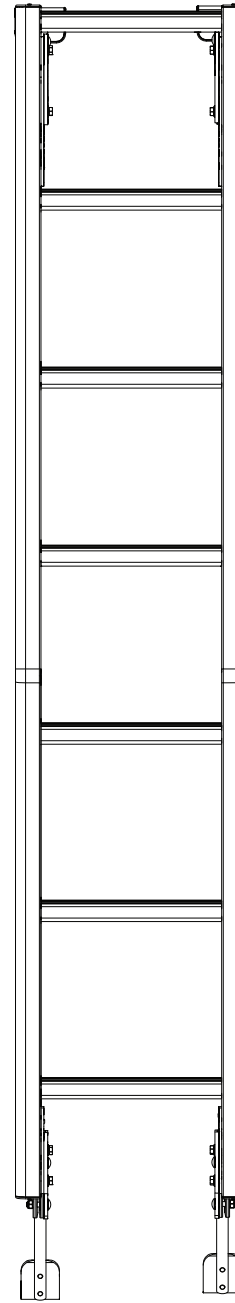
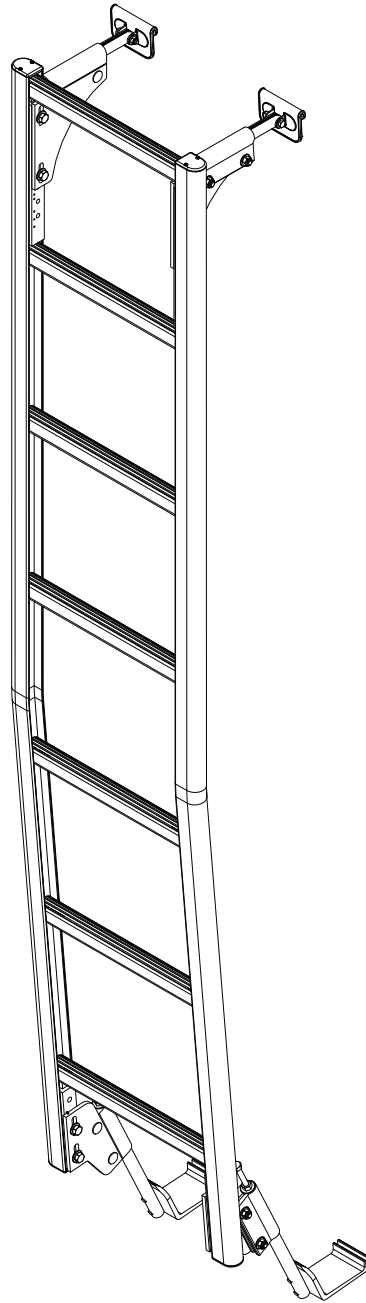

AAL-8011

2015+ Ford Transit-H3 Rear Door Access Ladder

Approximate dimensions as shown:

- A: Overall Ladder Width 15"
- B: Usable Ladder Width 11.75"
- C: Ladder Height 78"
- D: Door Seam Offset 3.125"

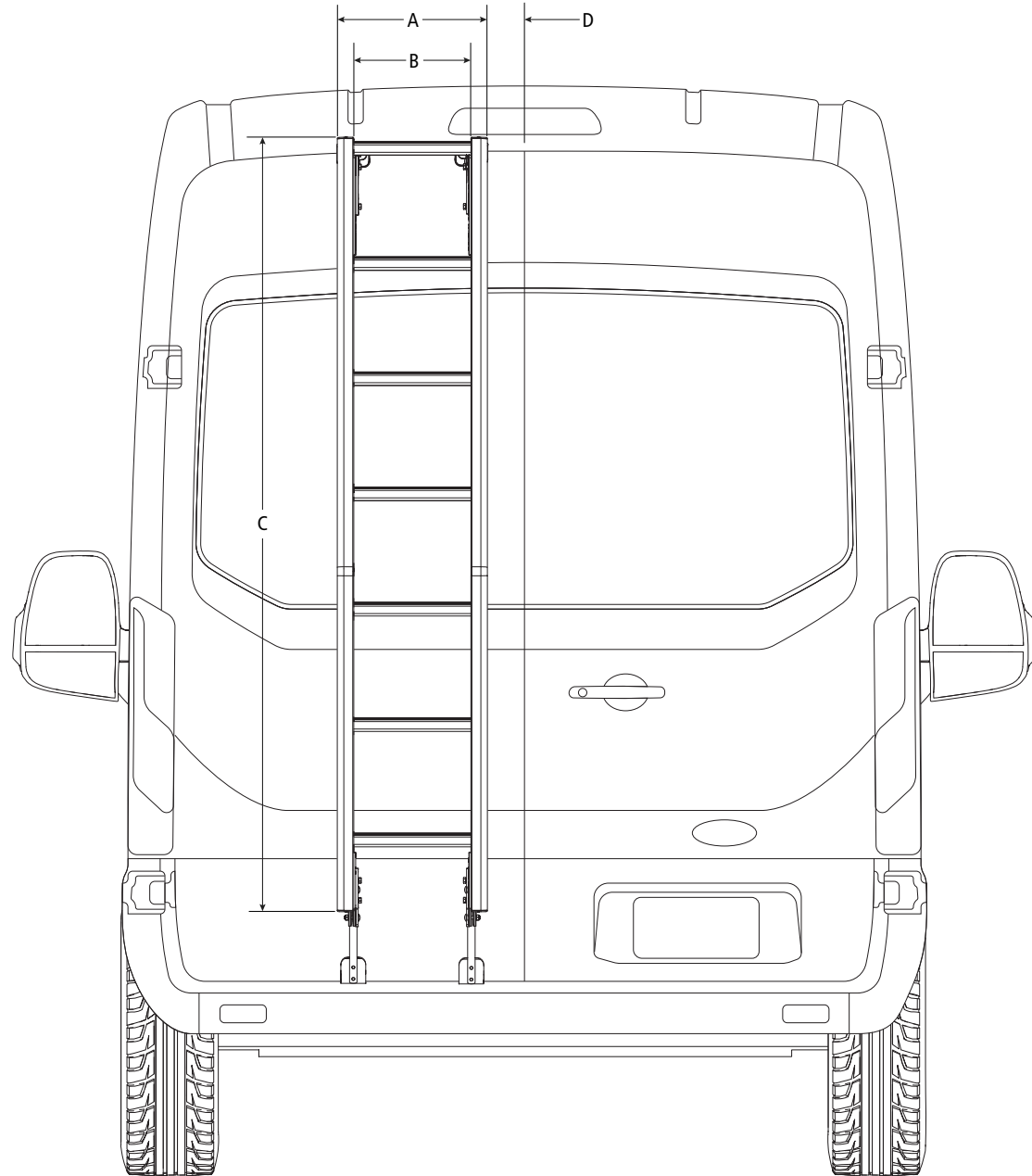

Assembly Manual also available:

AAL-8011

USOV-AAL8011-US01 Rev-B 0118