

CBA-3010

78" Crossbar Assembly Module

Dimensional Specifications on Page 2

Configuration as shown:

Base Left/Rotation Right
Two Crossbars, US Gen4
Finish: White Powder Coat
Weight: 36 lbs

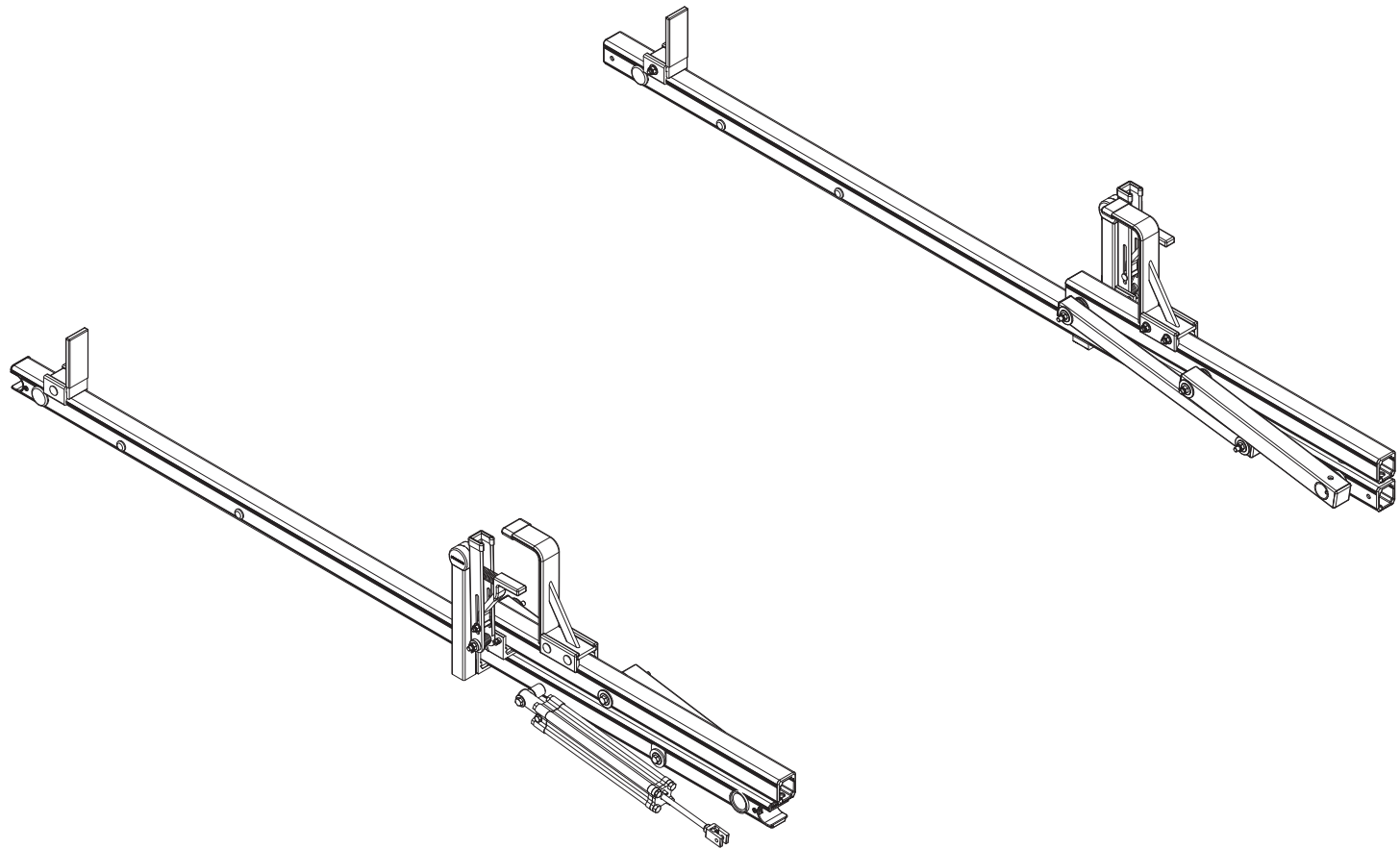

**Note: Mounting Hardware, Drive Shafts, and Connecting Bars are purchased separately.
For more information, please contact Sales & Support.*

CBA-3010

78" Crossbar Assembly Module

Approximate dimensions as shown:

- A: Crossbar Length..... 78"
- B: Assembly Height..... 12.50"

**Note: Mounting Hardware, Drive Shafts, and Connecting Bars are purchased separately.
For more information, please contact Sales & Support.*

Assembly Manual also available:

CBA-3010

USOV-CBA3010-US01 Rev-A 1118

**Other Parts and Hardware ordered separately*

Typical Assembly with CBA-3010

