

## AR-2103

### AluRack Side Rail Module, 112" Pair

*Configuration as shown:*

- Front Left Hand Rail, 60"
- Front Right Hand Rail, 60"
- Rear Left Hand Rail, 52"
- Rear Right Hand Rail, 52"
- Left/Right Hand Connectors, 6"
- Connector Hardware
- Finish: Anodized Aluminum
- Weight: 23 lbs

*Approximate dimensions as shown:*

- A: Overall Length..... 116"
- B: BTM Rail Length, Rear ..... 52"
- C: BTM Rail Length, Front..... 60"
- D: Overall BTM Length..... 112"

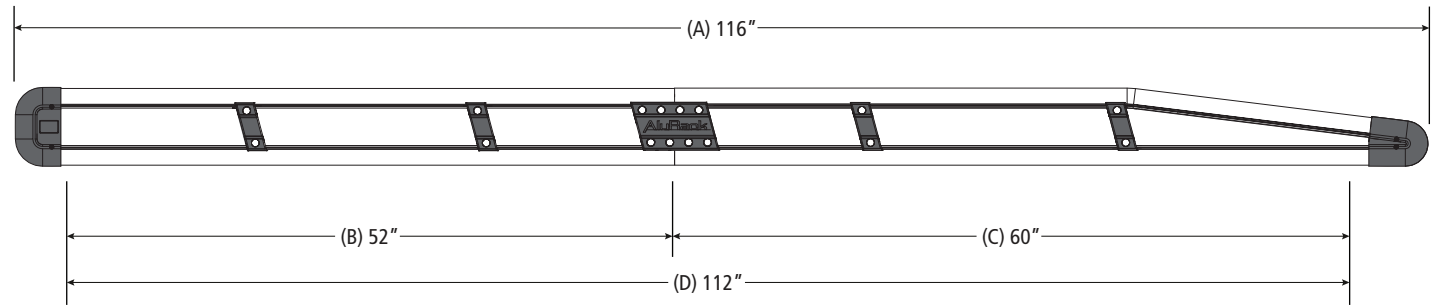
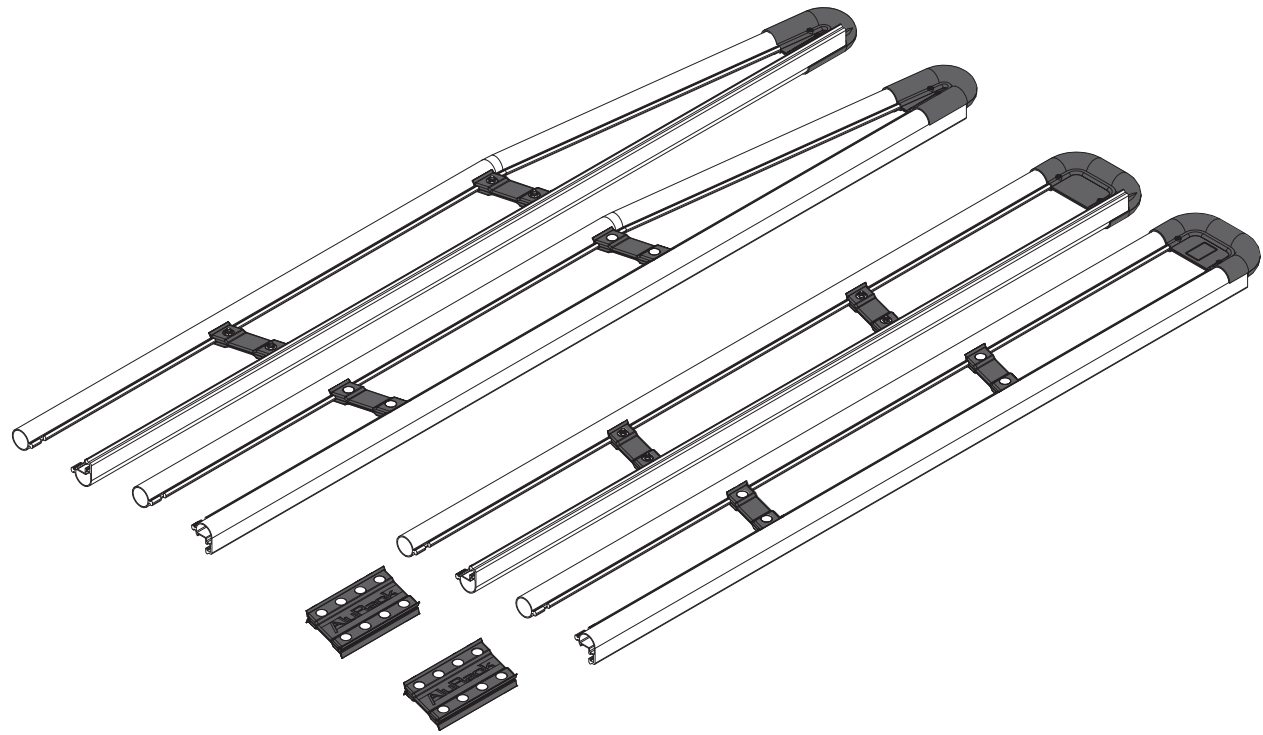

*Assembly Manual also available:*

## AR-2103

USOV-AR2103-US01 Rev-A 0219