

AR-2102

AluRack Side Rail Module, 96" Pair

Configuration as shown:

- Front Left Hand Rail, 60"
- Front Right Hand Rail, 60"
- Rear Left Hand Rail, 36"
- Rear Right Hand Rail, 36"
- Left/Right Hand Connectors, 6"
- Connector Hardware
- Finish: Anodized Aluminum
- Weight: 20 lbs

Approximate dimensions as shown:

- A: Overall Length..... 100"
- B: BTM Rail Length, Rear 36"
- C: BTM Rail Length, Front..... 60"
- D: Overall BTM Length..... 96"

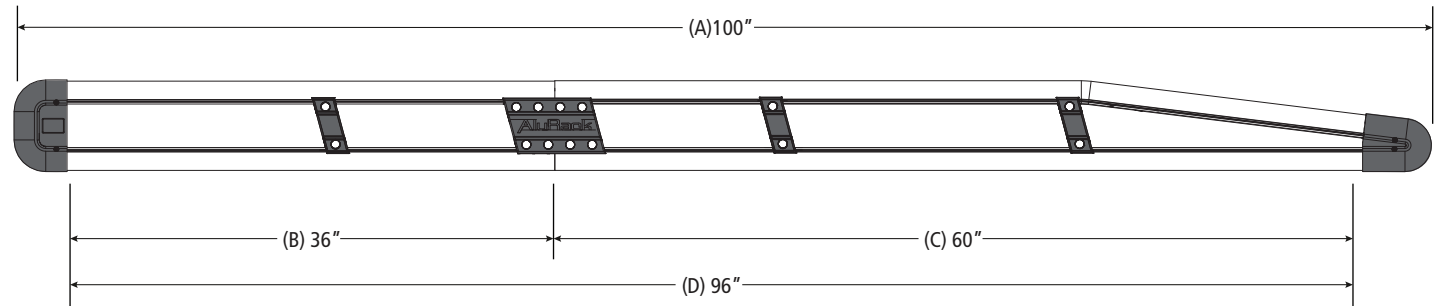
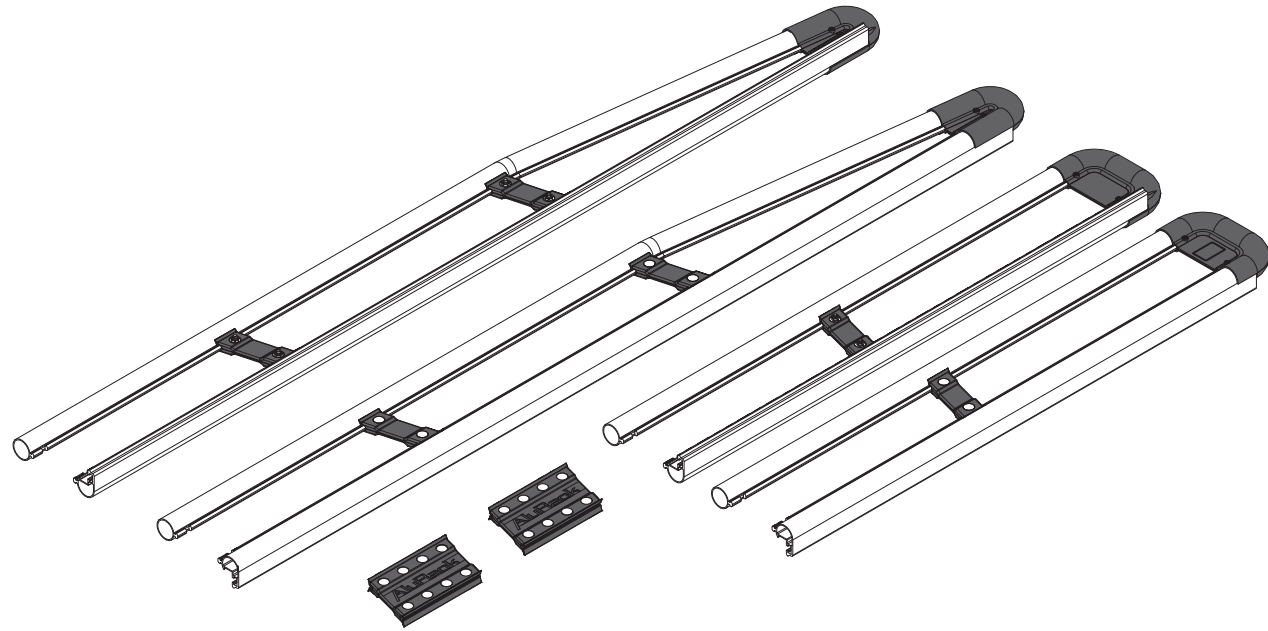

Assembly Manual also available:

AR-2102

USOV-AR2102-US01 Rev-A 0219