

CBR-0021

Middle Crossbar Module

Dimensional Specifications on Page 2

Configuration as shown:

Rotation Left, Powder Coat Finish

Weight: 14 lbs

A: Middle Crossbar

B: HKT-8407 Hardware Kit

C: 3' Connecting Bar Feature

[Modular Assembly Manuals](#)

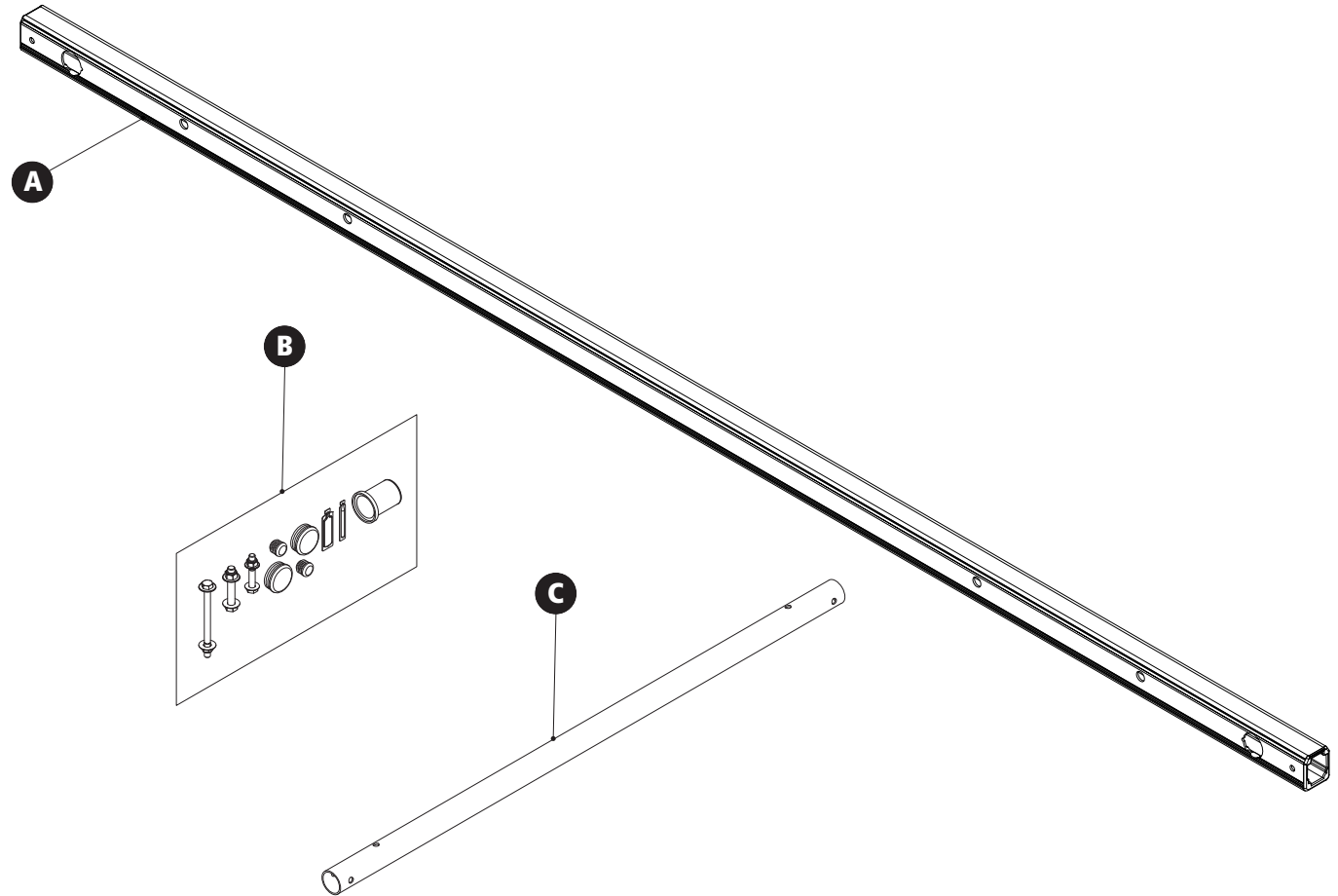

CBR-0021

Middle Crossbar Module

Approximate dimensions as shown:

- A: Crossbar Width 1.75"
- B: Connecting Bar Length 35.50"
- C: Crossbar Length 90"

