

CS-B10-24

Cantilever Shelving Layout for Generic Box Truck, 10' Module

Shelving Module, Natural Aluminum Finish
 79.25" Uprights, with Mounting Assembly
 48" x 24" Shelving Pair
 60" x 24" Shelving Pair
 Assembly Weight (empty): 167 lbs

Required Assemblies:

CALLOUT NUMBER	PART NUMBER	QTY
1	CSU-3003 79.25" Packaged Height	4
2	CSS-5002	1
3	CSS-5003	1

*Callouts on this page indicate full module assemblies only.

*See notes on this configuration & other options (sold separately) on page 2.

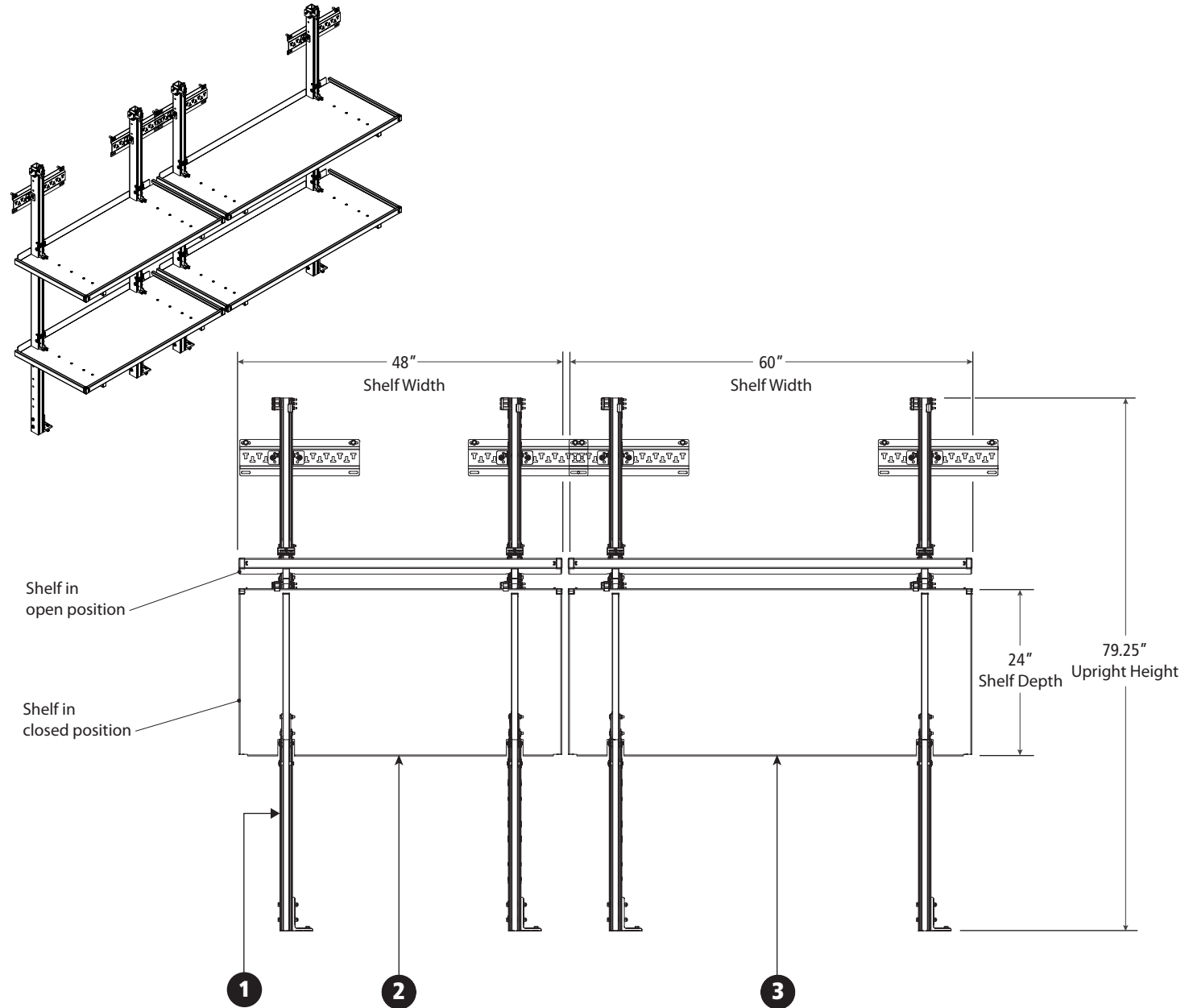

Cantilever Shelving—Load specifications:

Each shelf can support up to 60 lbs. per linear ft. Check OEM manufacturer recommendations for mounting location capacity weight limits.

CS-B10-24

Cantilever Shelving Layout for Generic Box Truck, 10' Module

Configuration Notes & Compatible Options (Sold Separately):

CALLOUT NUMBER	NOTE
1	Certain Box Trucks may include a door on the passenger side. Layout requirements and other OEM recommendations will need to be considered before installation.
2	Box Trucks may include various obstructions such as fuel line boxes or sliding rear doors. Clearance distances and OEM recommendations will need to be considered before installation.
3	Consideration may be required for box truck models with wheel wells. Uprights may be installed around or over wheel wells as needed. If necessary for your configuration, the Wheel Well Support Accessory is available (sold separately).
4	CSU-3100: Wheel Well Support (sold separately)
5	Customizable Upright Assemblies: Original Packaged Height vs. Cut Heights For further instructions regarding cutting locations, refer to Page 4 of your Upright Assembly Manual .

*Reminder: Consult Sales & Service regarding your vehicle size and configuration for appropriate shelving size accommodations.

