

CBA-3010

78" Crossbar Assembly Module

Dimensional Specifications on Page 2

Configuration as shown:

Base Left/Rotation Right
Two Crossbars, Powder Coat Finish
Weight: 36 lbs

- A: CB4-9701-78-01 RH Rear Rotation
- A1: BRT-8201 Ladder Stop
- A2: CBR-1711-78 Interlocking Crossbar
- A3: ELR-7073 L-Post
- A4: ELR-7282 Z-Post Bracket
- A5: ELR-7080 Z-Post
- A6: CYL-8801 Cylinder
- B: CB4-9101-78-01 RH Front Rotation
- B1: BRT-8201 Ladder Stop
- B2: CBR-1311-78 Crossbar
- B3: ELR-7073 L-Post
- B4: ELR-7282 Z-Post Bracket
- B5: ELR-7080 Z-Post
- C: Quick Start Guide (not shown)

[Modular Assembly Manuals](#)

**Note: Mounting Hardware, Drive Shafts, and Connecting Bars are purchased separately.
For more information, please contact Sales & Support.*

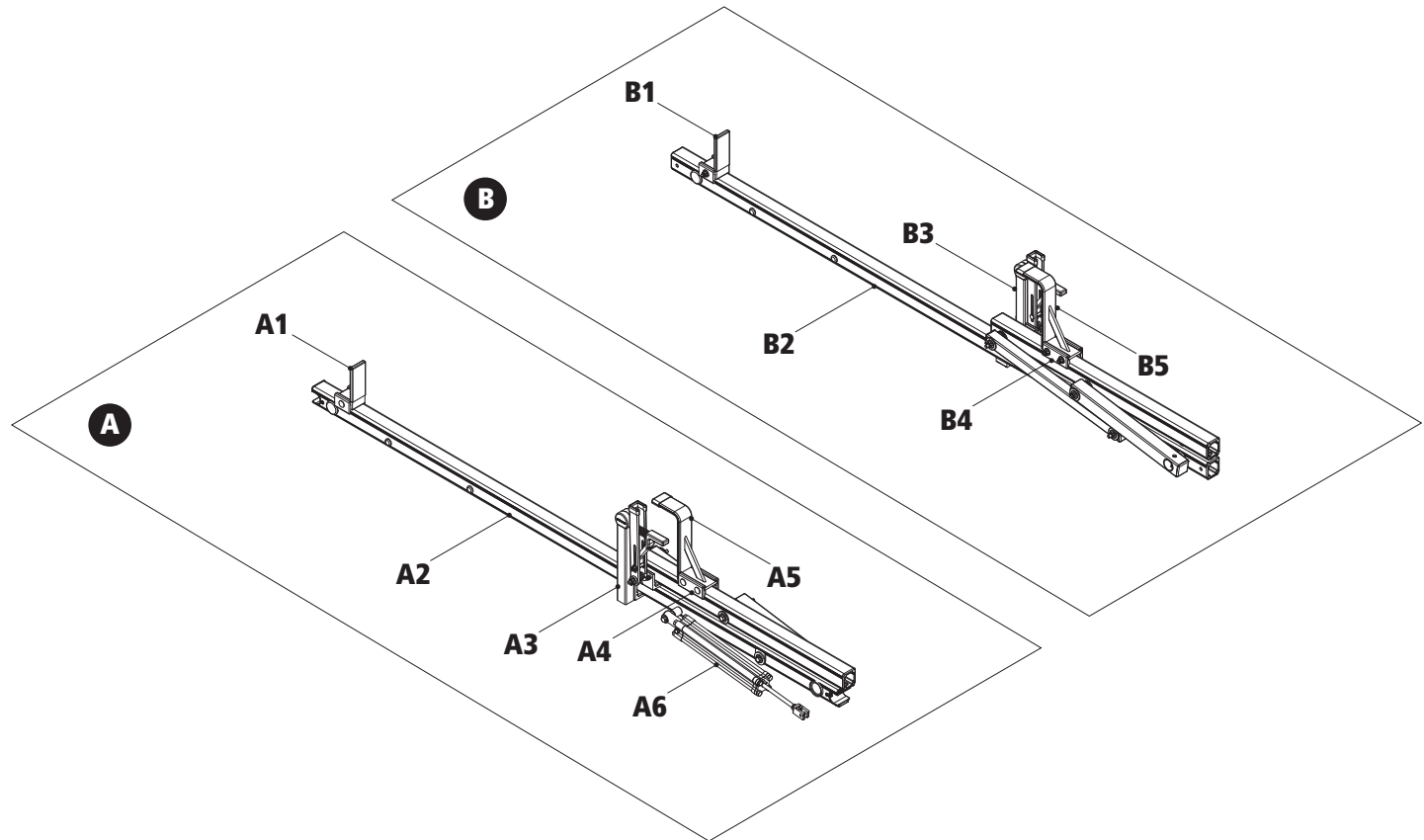

CBA-3010

78" Crossbar Assembly Module

Approximate dimensions as shown:

- A: Crossbar Length..... 78"
- B: Assembly Height..... 12.50"

**Note: Mounting Hardware, Drive Shafts, and Connecting Bars are purchased separately.
For more information, please contact Sales & Support.*

Assembly Manual also available:

[CBA-3010](#)

USOV-CBA3010-US01 Rev-A 1118

**Other Parts and Hardware ordered separately*

Typical Assembly with CBA-3010

