

FP-BT-7224

FoldPro Shelving Layout for Box Truck, 6' Assembly

FoldPro Shelving Assembly
73.00" Uprights [Pair] with Adjustable Mounting Brackets,
72" x 24" Shelving Pair

Assembly Weight (empty): 90 lbs

Required Assemblies:

CALLOUT NUMBER	PART NUMBER	QTY
1	FPU-3261	1
2	FPS-5204	1

*Callouts on this page indicate full module assemblies only.

*See notes on this configuration & other options (sold separately) on page 2.

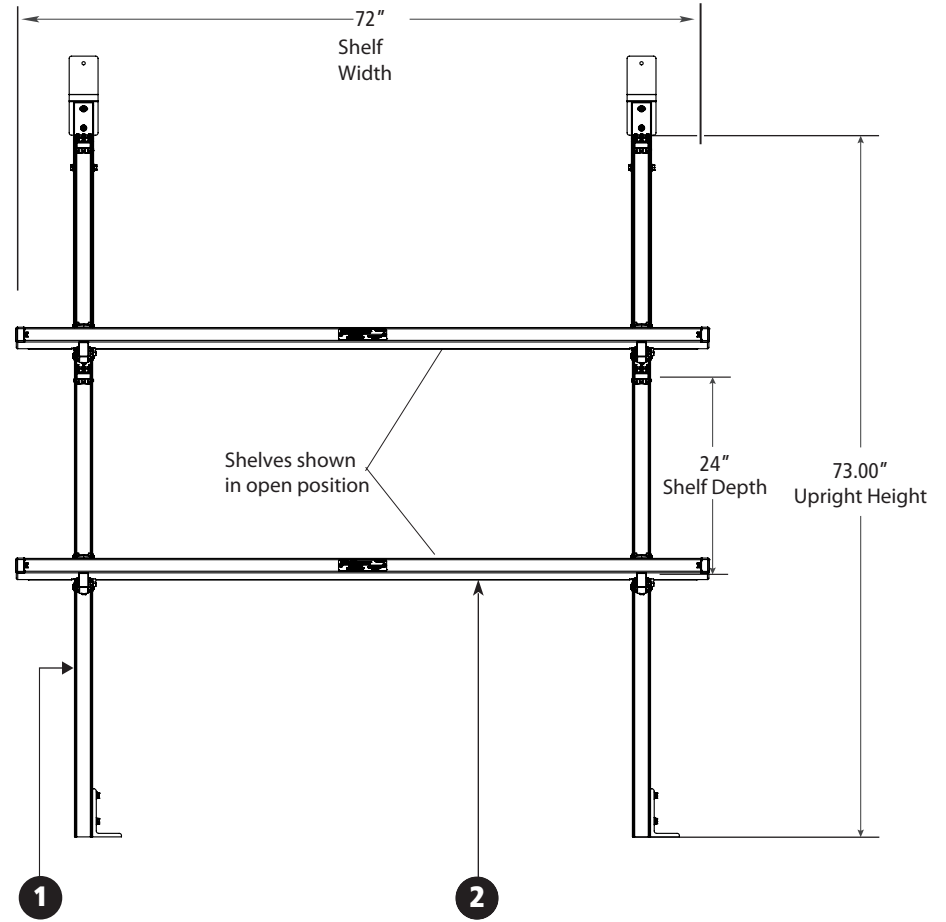
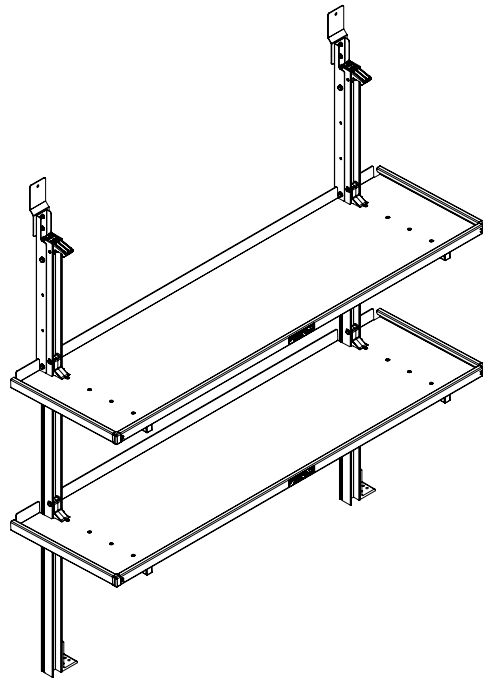

FoldPro Shelving—Load specifications:

Each shelf can support up to 400 lbs. Check OEM manufacturer recommendations for mounting location capacity weight limits.

FP-BT-7224

FoldPro Shelving Layout for Box Truck, 6' Assembly

Configuration Notes & Compatible Options (Sold Separately):

CALLOUT NUMBER	NOTE
1	Certain Box Trucks may include a door on the passenger side. Layout requirements and other OEM recommendations will need to be considered before installation.
2	Box Trucks may include various obstructions such as fuel line boxes or sliding rear doors. Clearance distances and OEM recommendations will need to be considered before installation.
3	Consideration may be required for box truck models with wheel wells. Uprights may be installed around or over wheel wells as needed. If necessary for your configuration, the Wheel Well Support Accessory is available (sold separately).
4	WW-1000: Wheel Well Support (sold separately)
5	Customizable Upright Assemblies: Original Packaged Height vs. Cut Heights For further instructions regarding cutting locations, refer to Page 4 of your Upright Assembly Manual .

*Reminder: Consult Sales & Service regarding your vehicle size and configuration for appropriate shelving size accommodations.

